



PLANET
PLASTİK ELEKTRİK

2024-2
FİYAT LİSTESİ



PLANET
PLASTİK ELEKTRİK

HAKKIMIZDA

Planet Plastik A.Ş., 2023 yılında kurulmuş ve faaliyetlerine başladığı günden itibaren, PVC kablo kanalları, PVC spiral borular ve çeşitli elektrik malzemeleri üretimi konusunda 20 yıllık deneyim, birikim ve tecrübesini kullanarak, gün geçtikçe kendini geliştirmiştir. 2.500 metrekarelik modern bir fabrikada faaliyet gösteren şirketimiz, Türkiye genelinde ve dünya pazarında büyük hedeflere sahip yenilikçi bir firmadır. Müşterilerimize en yüksek kalitede ürünler sunmayı ilke edinerek, en son teknolojiye sahip üretim makinelerle üretim yapmaktadır.

Ekip ve firma olarak Kalite bizim önceliğimizdir. Hedeflerimize doğru ilerlerken, deneyimli satış ekibimiz sürekli olarak pazar araştırmaları yapmakta ve değişen pazar koşullarına göre müşterilerimizin talepleri ve ihtiyaçları doğrultusunda AR-GE çalışmaları yapmaktadır. Kendi kalıphanelerimizde kalıp tasarımlarını gerçekleştirerek üretim aşamasına geçiriyor ve müşterilerimize daha geniş bir ürün yelpazesi sunmayı hedefliyoruz. Müşteri memnuniyetini en üst seviyede tutmak için sürekli olarak ürünlerimizi geliştirmek ve yenilikçi çözümler sunmak için çaba gösteriyoruz.

Planet Plastik A.Ş. olarak, sektörde öncü bir konumda olmayı sürdürmek ve müşterilerimize güvenilir ve kaliteli ürünler sunmaya devam etmek için çalışmalarımızı sürdürüyoruz.

ABOUT US

Planet Plastik A.Ş. was established in 2023 and since the day it started its activities, PVC cable trays, PVC 20 years of experience in the production of spiral pipes and various electrical materials He has improved himself day by day. Operating in a modern factory of 2,500 square meters, our company, across Türkiye and is an innovative company with great goals in the world market. We offer our customers the highest quality products By adopting the principle of presenting, it produces with the latest technology production machines.

As a team and company Quality is our priority. As we move towards our goals, experienced sales; our team is constantly on the market We conduct researches and in line with the demands and needs of our customers according to the changing market conditions; It carries out R&D studies. Production by realizing mold designs in our own molding houses; We aim to offer a wider range of products to our customers. Customer satisfaction We strive to continuously improve our products and provide innovative solutions to keep them at the highest level. we show. As Planet Plastik A.Ş., to maintain a leading position in the sector and reliable to our customers and we continue our efforts to continue to offer quality products.

CABLE TRUNKINGS

KABLO KANALLARI

**KABLOLARINIZ
GÜVENDE**

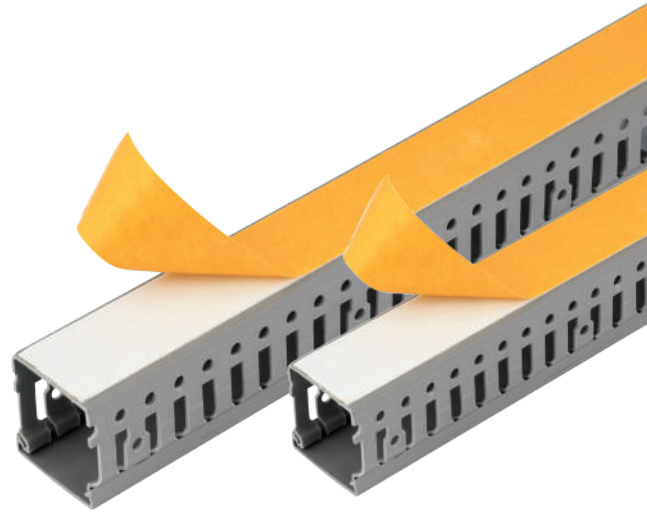
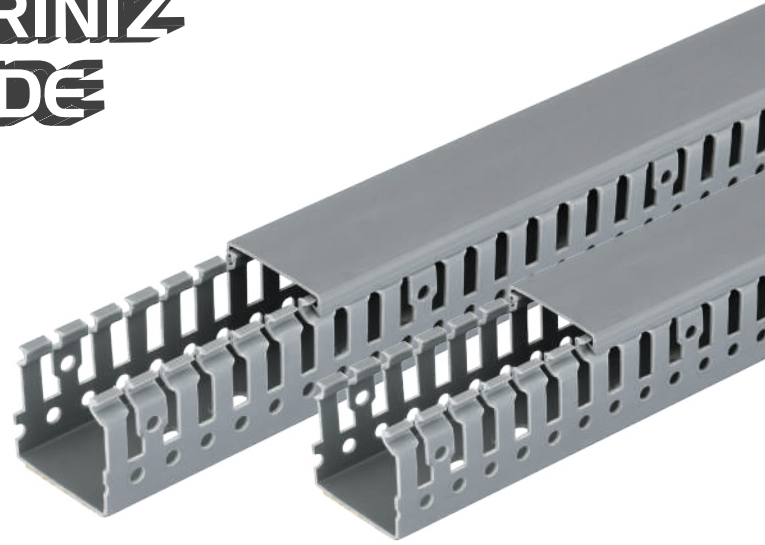

Alev Almaz
Unflammable



**Darbelere
Dayanıklı**
Impact Resistant

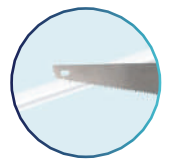

**İstenilen Ebatta
Kesilebilme Kolaylığı**
Ease of Cutting to
Desire Size

PVC KABLO KANALLARI KUTULU PVC CABLE TRUNKINGS BOX



Alev Almaz
Unflammmable



KOD CODE	ÜRÜN PRODUCT	AMBALAJ MİKTARI PACKAGE METER	FİYAT-MT PRICE-MT
PLNK-1212	12 x 12 Kablo Kanalı	450	12,07 ₺
PLNK-1510	15 x 10 Kablo Kanalı	440	13,92 ₺
PLNK-1616	16 x 16 Kablo Kanalı	304	15,55 ₺
PLNK-2010	20 x 10 Kablo Kanalı	330	15,33 ₺
PLNK-2516	25 x 16 Kablo Kanalı	200	22,07 ₺
PLNK-2525	25 x 25 Kablo Kanalı	130	29,55 ₺
PLNK-4016	40 x 16 Kablo Kanalı	116	33,66 ₺
PLNK-4025	40 x 25 Kablo Kanalı	80	40,52 ₺
PLNK-4040	40 x 40 Kablo Kanalı	72	50,95 ₺
PLNK-6040	60 x 40 Kablo Kanalı	48	79,95 ₺
PLNK-6060	60 x 60 Kablo Kanalı	40	106,09 ₺
PLNK-8040	80 x 40 Kablo Kanalı	40	130,81 ₺
PLNK-8060	80 x 60 Kablo Kanalı	32	133,78 ₺
PLNK-1040	100 x 40 Kablo Kanalı	36	137,88 ₺
PLNK-1060	100 x 60 Kablo Kanalı	24	157,87 ₺

YAPIŞKANLI PVC BANTLI KABLO KANALLARI KUTULU ADHESIVE CABLE TRUNKINGS BOX



Alev Almaz
Unflammable

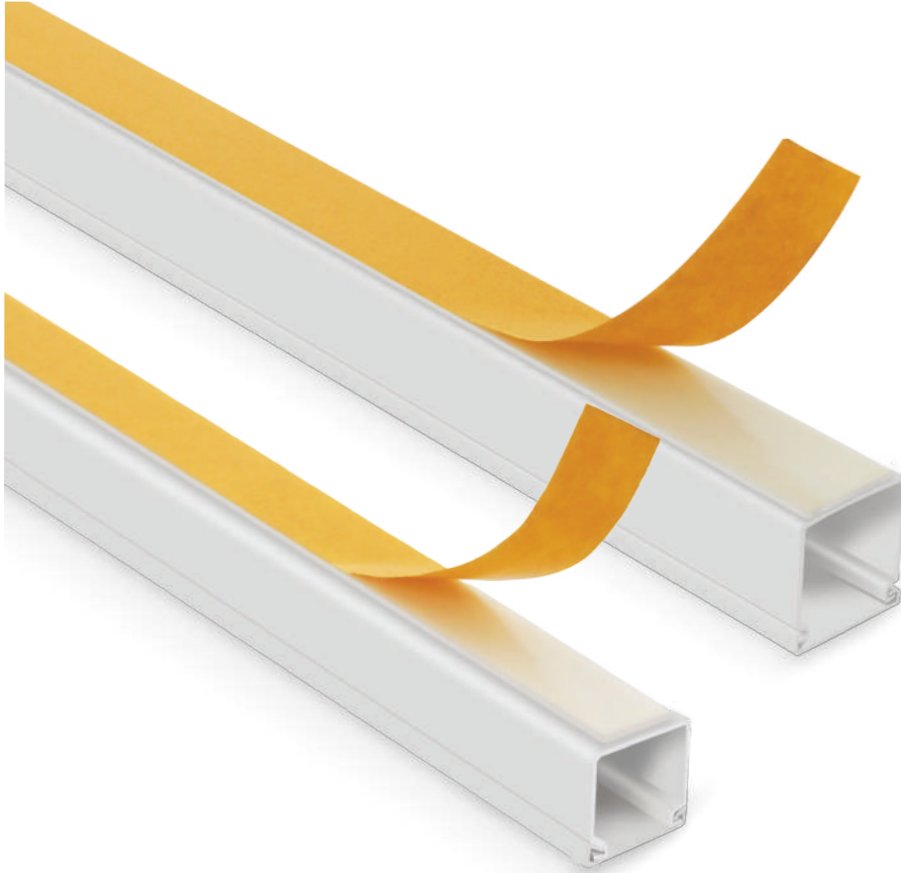

KOD CODE	ÜRÜN PRODUCT	AMBALAJ MİKTARI PACKAGE METER	FİYAT-MT PRICE-MT
PLNB-1212	12 x 12 Bantlı Kablo Kanalı	450	15.40 ₺
PLNB-1510	15 x 10 Bantlı Kablo Kanalı	440	17.10 ₺
PLNB-1616	16 x 16 Bantlı Kablo Kanalı	304	19.30 ₺
PLNB-2010	20 x 10 Bantlı Kablo Kanalı	330	20.29 ₺
PLNB-2516	25 x 16 Bantlı Kablo Kanalı	200	26.55 ₺
PLNB-2525	25 x 25 Bantlı Kablo Kanalı	130	35.38 ₺
PLNB-4016	40 x 16 Bantlı Kablo Kanalı	116	42.65 ₺
PLNB-4025	40 x 25 Bantlı Kablo Kanalı	80	50.13 ₺
PLNB-4040	40 x 40 Bantlı Kablo Kanalı	72	64.88 ₺
PLNB-6040	60 x 40 Bantlı Kablo Kanalı	48	102.28 ₺
PLNB-6060	60 x 60 Bantlı Kablo Kanalı	40	112.20 ₺

100 x 50 İÇTEN KAPAKLI KABLO KANALI
100 x 50 INSIDE COVER CABLE TRUNKING



Alev Almaz
Unflammmable

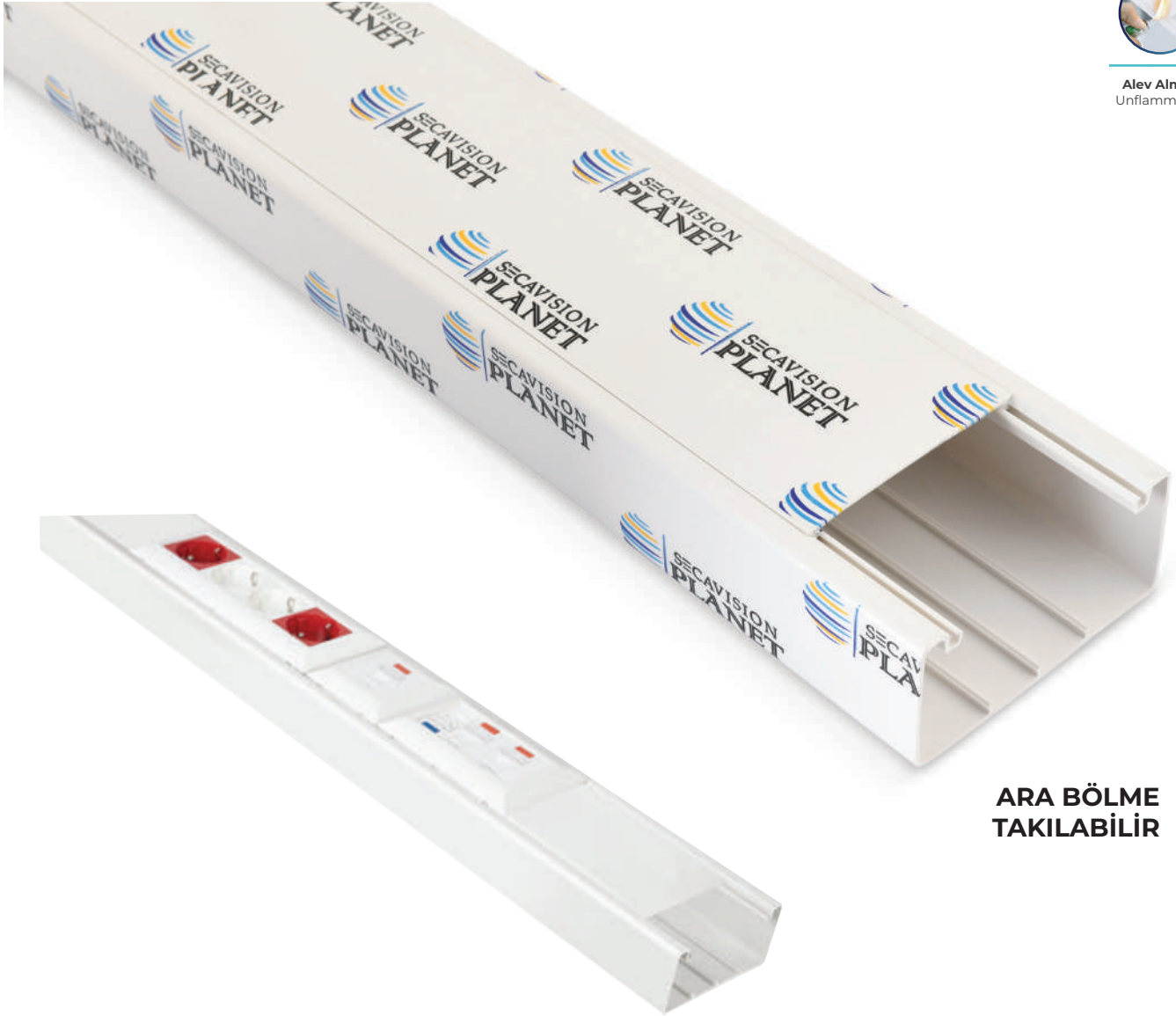

ARA BÖLME
TAKILABİLİR

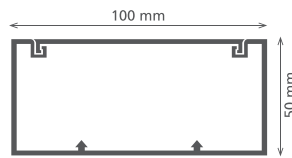

100 x 50

Ürün Kodu - Product Code	PLNK-10050
Uzunluk - Length	2 mt
Kesit - Section	100 x 50
Ambalaj Miktarı (m) - Package Total (m)	20 Mt.
Ambalaj Şekli - Package	Koli - Carton Box
Fiyat Mt - Price Mt	208.72₺

100 x 50 KABLO KANALI AKSESUARLARI

100 X 50 INSIDE COVER CABLE TRUNKING ACCESSORIES



KOD CODE	ÜRÜN PRODUCT	AMBALAJ MİKTARI PACKAGE METER	FİYAT-ADET PRICE-PCS
PLN-AKS-01	Ara Bölme Divider	100 mt	89.58 ₺
PLN-AKS-02	L Bağlantı Elemanı 90° 90° Corner Piece	12	119.71 ₺
PLN-AKS-03	Dış Köşe (Hareketli) External Corner	10	96.37 ₺
PLN-AKS-04	İç Köşe (Hareketli) Internal Corner	12	96.37 ₺
PLN-AKS-05	T Bağlantı Elemanı T Branches	12	119.71 ₺
PLN-AKS-06	Sonlandırma Kapağı End Cover	24	68.81 ₺
PLN-AKS-07	Kanal Birleştirme Parçası Junction Piece	24	68.51 ₺
PLN-AKS-08	Tekli 45 x 45 Priz Montaj Seti Single Frame Cover Set For 45 x 45	12	72.50 ₺
PLN-AKS-09	İkili 45 x 45 Priz Montaj Seti Double Frame Cover Set For 45 x 45	12	96.72 ₺
PLN-AKS-010	Üçlü 45 x 45 Priz Montaj Seti Triple Frame Cover Set For 45 x 45	12	109.38 ₺
PLN-AKS-011	Dörtlü 45 x 45 Priz Montaj Seti Quadruple Frame Cover Set For 45 x 45	20	197.40 ₺
PLN-AKS-012	İngiliz Tip Tekli Priz Çerçevesi British Type Socket Frame	100	150,00 ₺
PLN-AKS-013	İngiliz Tip İkili Priz Çerçevesi British Type Double Socket Frame	100	158,40 ₺
PLN-AKS-014	45x45 Data ve Telefon Priz Kapağı Tekli 45x45 Data and Telephone Socket Single	50	57.15 ₺
PLN-AKS-015	45x45 Data ve Telefon Priz Kapağı 2'li 45x45 Data and Telephone Socket Double	50	95.33 ₺
PLN-AKS-016	Topraklı UPS Priz Single UPS Socket	50	127.19 ₺
PLN-AKS-017	Tekli Şebeke Prizi Single Grounded Socket	50	110.29 ₺

AHŞAP DESENLİ KABLO KANALLARI KUTULU WOOD PATTERNED CABLE TRUNKINGS BOX



Alev Almaz
Unflammmable



Sipariş üzerine üretilir.

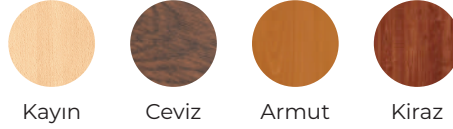

Kayın

Ceviz

Armut

Kiraz



KOD CODE	ÜRÜN PRODUCT	AMBALAJ MİKTARI PACKAGE METER	FİYAT PRICE
PLNBA-1212	12 x 12 Bantlı Kablo Kanalı	450	Fiyat Sorunuz
PLNBA-1510	15 x 10 Bantlı Kablo Kanalı	440	Fiyat Sorunuz
PLNBA-1616	16 x 16 Bantlı Kablo Kanalı	304	Fiyat Sorunuz
PLNBA-2010	20 x 10 Bantlı Kablo Kanalı	330	Fiyat Sorunuz
PLNBA-2516	25 x 16 Bantlı Kablo Kanalı	200	Fiyat Sorunuz
PLNBA-2525	25 x 25 Bantlı Kablo Kanalı	130	Fiyat Sorunuz
PLNBA-4016	40 x 16 Bantlı Kablo Kanalı	116	Fiyat Sorunuz
PLNBA-4025	40 x 25 Bantlı Kablo Kanalı	80	Fiyat Sorunuz
PLNBA-4040	40 x 40 Bantlı Kablo Kanalı	72	Fiyat Sorunuz
PLNBA-6040	60 x 40 Bantlı Kablo Kanalı	48	Fiyat Sorunuz
PLNBA-6060	60 x 60 Bantlı Kablo Kanalı	40	Fiyat Sorunuz

PANO TİPİ KABLO KANALLARI KUTULU SLOTTED CABLE TRUNKINGS BOX

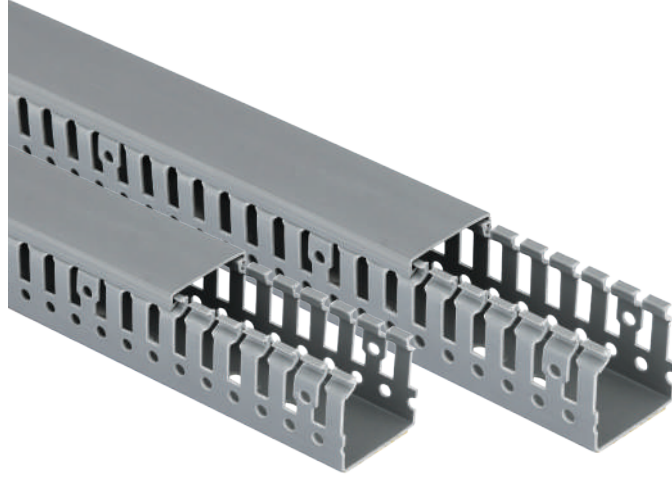

Alev Almaz
Unflammmable



KOD CODE	ÜRÜN PRODUCT	AMBALAJ MİKTARI PACKAGE METER	FİYAT-MT PRICE-MT
PLNP-2525	25 x 25 Pano Tipi Kablo Kanalı	126	60.22 ₺
PLNP-2540	25 x 40 Pano Tipi Kablo Kanalı	84	78.87 ₺
PLNP-4040	40 x 40 Pano Tipi Kablo Kanalı	72	107.52 ₺
PLNP-4060	40 x 60 Pano Tipi Kablo Kanalı	48	158.14 ₺
PLNP-6060	60 x 60 Pano Tipi Kablo Kanalı	24	179.64 ₺

PANO TİPİ YAPIŞKANLI KABLO KANALLARI KUTULU SLOTTED ADHESIVE CABLE TRUNKINGS BOX

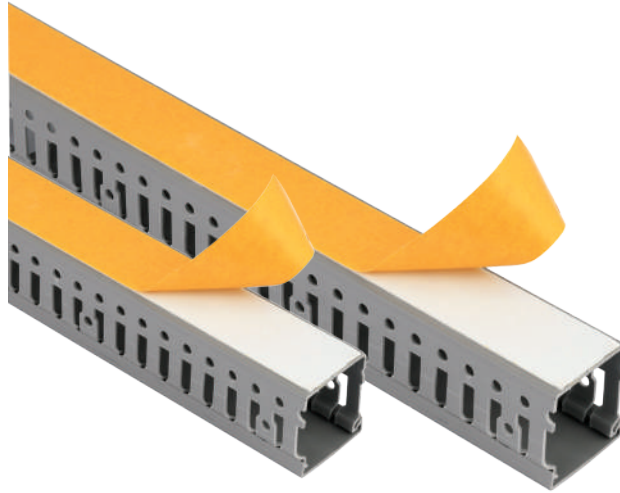

Alev Almaz
Unflammmable



KOD CODE	ÜRÜN PRODUCT	AMBALAJ MİKTARI PACKAGE METER	FİYAT-MT PRICE-MT
PLNPB-2525	25 x 25 Yapışkanlı Pano Tipi Kablo Kanalı	126	78.28 ₺
PLNPB-2540	25 x 40 Yapışkanlı Pano Tipi Kablo Kanalı	84	102.51 ₺
PLNPB-4040	40 x 40 Yapışkanlı Pano Tipi Kablo Kanalı	72	139.77 ₺
PLNPB-4060	40 x 60 Yapışkanlı Pano Tipi Kablo Kanalı	48	205.58 ₺
PLNPB-6060	60 x 60 Yapışkanlı Pano Tipi Kablo Kanalı	24	233.54 ₺

BALIK SIRTI KABLO KANALLARI KUTULU OVERFLOOR CABLE TRUNKINGS BOX



Alev Almaz
Unflammable



KOD CODE	ÜRÜN PRODUCT	AMBALAJ MİKTARI PACKAGE METER	FİYAT-MT PRICE-MT
PLNK-5012	50 x 12 Balık Sırtlı Kablo Kanalı	60	72.60 ₺
PLNK-7020	70 x 20 Balık Sırtlı Kablo Kanalı	28	147.59 ₺
PLNK-9020	90 x 20 Balık Sırtlı Kablo Kanalı	20	196.97 ₺

YAPIŞKANLI BALIK SIRTI KABLO KANALLARI KUTULU ADHESIVE OVERFLOOR CABLE TRUNKINGS BOX



Alev Almaz
Unflammable

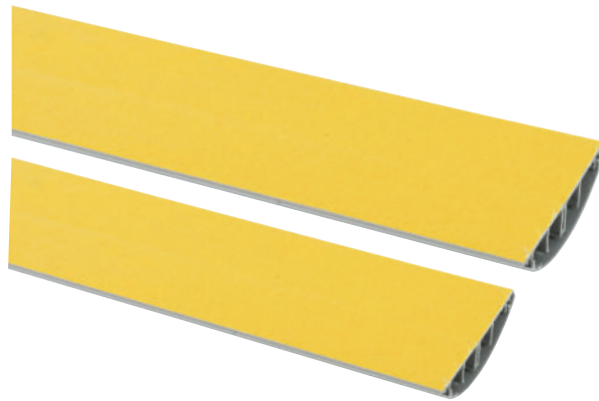

KOD CODE	ÜRÜN PRODUCT	AMBALAJ MİKTARI PACKAGE METER	FİYAT-MT PRICE-MT
PLNKB-5012	50 x 12 Bantlı Balık Sırtlı Kablo Kanalı	60	83.67 ₺
PLNKB-7020	70 x 20 Bantlı Balık Sırtlı Kablo Kanalı	28	155.12 ₺
PLNKB-9020	90 x 20 Bantlı Balık Sırtlı Kablo Kanalı	20	215.60 ₺

IP 65

ABS BOARD

ABS PANO



ABS PANOLAR OPAK KAPAKLI
ABS Board

YENİ
ÜRÜN
NEW
PRODUCT

IP 65
IK 10



KOD CODE	ÜRÜN PRODUCT	AMBALAJ MİKTARI PACKAGE METER	FİYAT-ADET PRICE-PCS
PLN-ABS-120	200x300x120 ABS Pano	1	730,00 ₺
PLN-ABS-150	250x350x150 ABS Pano	1	920,00 ₺
PLN-ABS-170	300x400x180 ABS Pano	1	1.365,80 ₺
PLN-ABS-220	300x400x220 ABS Pano	1	1.995,00 ₺
PLN-ABS-190	350x500x190 ABS Pano	1	2.010,00 ₺
PLN-ABS-180	400x500x180 ABS Pano	1	1.917,90 ₺
PLN-ABS-210	400x500x210 ABS Pano	1	1.975,00 ₺
PLN-ABS-200	400x600x200 ABS Pano	1	2.345,00 ₺
PLN-ABS-230	500x600x230 ABS Pano	1	3.515,00 ₺
PLN-ABS-250	500x700x250 ABS Pano	1	4.180,00 ₺
PLN-ABS-280	600x800x280 ABS Pano	1	6.290,00 ₺

ABS PANOLAR ŞEFFAF KAPAKLI
Panel Boards With Pc Transparent Door



KOD CODE	ÜRÜN PRODUCT	AMBALAJ MİKTARI PACKAGE METER	FİYAT-ADET PRICE-PCS
PLN-PC-120	200x300x120 Şeffaf ABS Pano	1	838.35 ₺
PLN-PC-150	250x350x150 Şeffaf ABS Pano	1	1.073.60 ₺
PLN-PC-170	300x400x180 Şeffaf ABS Pano	1	1.411.37 ₺
PLN-PC-220	300x400x220 Şeffaf ABS Pano	1	2.080.00 ₺
PLN-PC-190	350x500x190 Şeffaf ABS Pano	1	2.185.00 ₺
PLN-PC-180	400x500x180 Şeffaf ABS Pano	1	2.246.20 ₺
PLN-PC-210	400x500x210 Şeffaf ABS Pano	1	2.394.00 ₺
PLN-PC-200	400x600x200 Şeffaf ABS Pano	1	2.581.00 ₺
PLN-PC-230	500x600x230 Şeffaf ABS Pano	1	3.740.95 ₺
PLN-PC-250	500x700x250 Şeffaf ABS Pano	1	4.939.25 ₺
PLN-PC-280	600x800x280 Şeffaf ABS Pano	1	6.657.35 ₺

BANYO ASPIRATÖRÜ BATHROOM ASPIRATOR



ASPIRATÖR 100MM

Ürün Kodu - Product Code

PLN-BNY-100



SÜPER
SESSİZ

Çalışma Akımı - Operation Voltage	220-240 V / 50-60 Hz
Emiş Hacmi - Airflow	100 m ³ /h
Devir Hızı - Round Speed	2250 rpm
Güç - Power	15W
Fiyat Adet - Price PCS	436.80 ₺

Kutu - Box Pcs. : 1/20



ASPIRATÖR 120MM

Ürün Kodu - Product Code

PLN-BNY-120



SÜPER
SESSİZ

Çalışma Akımı - Operation Voltage	220-240 V / 50-60 Hz
Emiş Hacmi - Airflow	120 m ³ /h
Devir Hızı - Round Speed	1900 rpm
Güç - Power	20W
Fiyat Adet - Price PCS	495.60 ₺

Kutu - Box Pcs. : 1/20



ASPIRATÖR 150MM

Ürün Kodu - Product Code

PLN-BNY-150



SÜPER
SESSİZ

Çalışma Akımı - Operation Voltage	220-240 V / 50-60 Hz
Emiş Hacmi - Airflow	150 m ³ /h
Devir Hızı - Round Speed	1800 rpm
Güç - Power	25W
Fiyat Adet - Price PCS	636.87 ₺

Kutu - Box Pcs. : 1/20



TTR KABLolu (BAKIR) SIVI SEVİYE FLATÖRLERİ
LIQUID LEVEL FLOATERS WITH TTR CABLE (COPPER) v**IP 68****YENİ
ÜRÜN**
NEW
PRODUCT

Kablo / Cable - TTR

Voltaj / Voltage - 220-250V

Koruma Sınıfı - IP68

Çalışma sıcaklığı / Operational Temp -25 + 80°C

KOD CODE	ÜRÜN PRODUCT	ÖLÇÜ DIMENSIONS	KOLİ ADET BOX QTY	FİYAT-Adet PRICE-PCS
PLNF-01	TTR Kablolulu Sıvı Seviye Flatörü	1,6 mt	18	680.00 ₺
PLNF-02	TTR Kablolulu Sıvı Seviye Flatörü	3 mt	18	899.00 ₺
PLNF-03	TTR Kablolulu Sıvı Seviye Flatörü	5 mt	18	1.130.00 ₺
PLNF-04	TTR Kablolulu Sıvı Seviye Flatörü	10 mt	18	2.066.00 ₺

ÇELİK SİRAL BORU STEEL SPIRAL PIPE CONDOIT



KOD CODE	ÜRÜN ADI PRODUCT NAME	İÇ ÇAP INSIDE	DIŞ ÇAP OUTSIDE	MT. PACK	FİYAT-MT PRICE-MT
PLN-ÇLK-9	9 mm Çelik Spiral Boru	9 mm	12.1	50	17.70 ₺
PLN-ÇLK-11	11 mm Çelik Spiral Boru	11 mm	14.1	50	18.53 ₺
PLN-ÇLK-14	14 mm Çelik Spiral Boru	14 mm	17.1	50	22.45 ₺
PLN-ÇLK-16	16 mm Çelik Spiral Boru	16 mm	19.1	50	25.09 ₺
PLN-ÇLK-18	18 mm Çelik Spiral Boru	18 mm	21.0	50	27.44 ₺
PLN-ÇLK-21	21 mm Çelik Spiral Boru	21 mm	24.0	50	31.83 ₺
PLN-ÇLK-26	26 mm Çelik Spiral Boru	26 mm	29.0	25	42.96 ₺
PLN-ÇLK-29	29 mm Çelik Spiral Boru	29 mm	31.0	25	47.65 ₺
PLN-ÇLK-32	32 mm Çelik Spiral Boru	32 mm	35.0	25	50.48 ₺
PLN-ÇLK-35	35 mm Çelik Spiral Boru	35 mm	38.0	25	56.48 ₺
PLN-ÇLK-37	37 mm Çelik Spiral Boru	37 mm	41.0	25	63.65 ₺
PLN-ÇLK-40	40 mm Çelik Spiral Boru	40 mm	43.0	25	73.59 ₺
PLN-ÇLK-42	42 mm Çelik Spiral Boru	42 mm	45.0	25	75.58 ₺
PLN-ÇLK-45	45 mm Çelik Spiral Boru	45 mm	48.0	25	89.50 ₺
PLN-ÇLK-50	50 mm Çelik Spiral Boru	50 mm	53.0	25	100.84 ₺

ÇELİK SİRAL BORU TELLİ STEEL SPIRAL PIPE WIRE



KOD CODE	ÜRÜN ADI PRODUCT NAME	İÇ ÇAP INSIDE	DIŞ ÇAP OUTSIDE	MT. PACK	FİYAT-MT PRICE-MT
PLN-ÇLKT-9	9 mm Çelik Spiral Boru Telli	9 mm	12.1	50	19.89 ₺
PLN-ÇLKT-11	11 mm Çelik Spiral Boru Telli	11 mm	14.1	50	22.95 ₺
PLN-ÇLKT-14	14 mm Çelik Spiral Boru Telli	14 mm	17.1	50	26.00 ₺
PLN-ÇLKT-16	16 mm Çelik Spiral Boru Telli	16 mm	19.1	50	27.54 ₺
PLN-ÇLKT-18	18 mm Çelik Spiral Boru Telli	18 mm	21.0	50	38.06 ₺
PLN-ÇLKT-21	21 mm Çelik Spiral Boru Telli	21 mm	24.0	50	41.14 ₺
PLN-ÇLKT-26	26 mm Çelik Spiral Boru Telli	26 mm	29.0	25	43.98 ₺
PLN-ÇLKT-29	29 mm Çelik Spiral Boru Telli	29 mm	31.0	25	47.81 ₺
PLN-ÇLKT-32	32 mm Çelik Spiral Boru Telli	32 mm	35.0	25	57.37 ₺
PLN-ÇLKT-35	35 mm Çelik Spiral Boru Telli	35 mm	38.0	25	60.31 ₺
PLN-ÇLKT-37	37 mm Çelik Spiral Boru Telli	37 mm	41.0	25	68.07 ₺
PLN-ÇLKT-40	40 mm Çelik Spiral Boru Telli	40 mm	43.0	25	72.49 ₺
PLN-ÇLKT-42	42 mm Çelik Spiral Boru Telli	42 mm	45.0	25	80.32 ₺
PLN-ÇLKT-45	45 mm Çelik Spiral Boru Telli	45 mm	48.0	25	95.62 ₺
PLN-ÇLKT-50	50 mm Çelik Spiral Boru Telli	50 mm	53.0	25	107.12 ₺

PVC İZOLELİ ÇELİK SİRAL BORU

PVC INSULATED STEEL SPIRAL CONDUIT

KOD CODE	ÜRÜN ADI PRODUCT NAME	İÇ ÇAP INSIDE	DIŞ ÇAP OUTSIDE	MT. PACK	FİYAT-MT PRICE-MT
PLN-İZL-9	9 mm İzoleli Çelik Spiral Boru	9 mm	13	50	23.86 ₺
PLN-İZL-11	11 mm İzoleli Çelik Spiral Boru	11 mm	15	50	25.06 ₺
PLN-İZL-14	14 mm İzoleli Çelik Spiral Boru	14 mm	18	50	30.92 ₺
PLN-İZL-16	16 mm İzoleli Çelik Spiral Boru	16 mm	20	50	34.20 ₺
PLN-İZL-18	18 mm İzoleli Çelik Spiral Boru	18 mm	22	50	38.58 ₺
PLN-İZL-21	21 mm İzoleli Çelik Spiral Boru	21 mm	25	50	45.11 ₺
PLN-İZL-26	26 mm İzoleli Çelik Spiral Boru	26 mm	31	25	56.90 ₺
PLN-İZL-29	29 mm İzoleli Çelik Spiral Boru	29 mm	35	25	62.89 ₺
PLN-İZL-32	32 mm İzoleli Çelik Spiral Boru	32 mm	36	25	69.62 ₺
PLN-İZL-35	35 mm İzoleli Çelik Spiral Boru	35 mm	39	25	73.86 ₺
PLN-İZL-37	37 mm İzoleli Çelik Spiral Boru	37 mm	41	25	89.50 ₺
PLN-İZL-40	40 mm İzoleli Çelik Spiral Boru	40 mm	44	25	103.36 ₺
PLN-İZL-42	42 mm İzoleli Çelik Spiral Boru	42 mm	46	25	107.03 ₺
PLN-İZL-45	45 mm İzoleli Çelik Spiral Boru	45 mm	49	25	127.30 ₺
PLN-İZL-50	50 mm İzoleli Çelik Spiral Boru	50 mm	54	25	139.23 ₺



KILAVUZ TELLİ İZOLELİ ÇELİK SİRAL BORU

PVC INSULATED STEEL SPIRAL CONDUIT WITH GUIDE

KOD CODE	ÜRÜN ADI PRODUCT NAME	İÇ ÇAP INSIDE	DIŞ ÇAP OUTSIDE	MT. PACK	FİYAT-MT PRICE-MT
PLN-İZLT-9	9 mm İzoleli Çelik Spiral Boru	9 mm	13	50	25.60 ₺
PLN-İZLT-11	11 mm İzoleli Çelik Spiral Boru	11 mm	15	50	27.72 ₺
PLN-İZLT-14	14 mm İzoleli Çelik Spiral Boru	14 mm	18	50	34.42 ₺
PLN-İZLT-16	16 mm İzoleli Çelik Spiral Boru	16 mm	20	50	35.56 ₺
PLN-İZLT-18	18 mm İzoleli Çelik Spiral Boru	18 mm	22	50	41.30 ₺
PLN-İZLT-21	21 mm İzoleli Çelik Spiral Boru	21 mm	25	50	47.16 ₺
PLN-İZLT-26	26 mm İzoleli Çelik Spiral Boru	26 mm	31	25	58.60 ₺
PLN-İZLT-29	29 mm İzoleli Çelik Spiral Boru	29 mm	35	25	63.09 ₺
PLN-İZLT-32	32 mm İzoleli Çelik Spiral Boru	32 mm	36	25	74.58 ₺
PLN-İZLT-35	35 mm İzoleli Çelik Spiral Boru	35 mm	39	25	76.50 ₺
PLN-İZLT-37	37 mm İzoleli Çelik Spiral Boru	37 mm	41	25	91.50 ₺
PLN-İZLT-40	40 mm İzoleli Çelik Spiral Boru	40 mm	44	25	96.30 ₺
PLN-İZLT-42	42 mm İzoleli Çelik Spiral Boru	42 mm	46	25	107.10 ₺
PLN-İZLT-45	45 mm İzoleli Çelik Spiral Boru	45 mm	49	25	114.75 ₺
PLN-İZLT-50	50 mm İzoleli Çelik Spiral Boru	50 mm	54	25	137.70 ₺

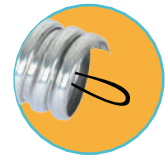

PLASTİK HAFİF SERİ SİYAH SİRİRAL BORU PLASTIC LIGHT SERIES BLACK SİRİRAL PIPE



KOD CODE	ÜRÜN ADI PRODUCT NAME	İÇ ÇAP INSIDE	DIŞ ÇAP OUTSIDE	MT. PACK	FİYAT-MT PRICE-MT
PLN-PLS-14	14 mm Plastik SİRİRAL Boru	14	18.1	100	7.47 ₺
PLN-PLS-16	16 mm Plastik SİRİRAL Boru	16	19.8	100	9.40 ₺
PLN-PLS-18	18 mm Plastik SİRİRAL Boru	18	22.1	100	11.17 ₺
PLN-PLS-20	20 mm Plastik SİRİRAL Boru	20	24.2	100	13.00 ₺
PLN-PLS-25	25 mm Plastik SİRİRAL Boru	25	28.9	100	16.87 ₺
PLN-PLS-32	32 mm Plastik SİRİRAL Boru	32	36	50	26.27 ₺

PLASTİK SİYAH HAFİF SERİ SİRİRAL BORU KILAVUZ TELLİ BLACK PVC LIGHT SERIES SİRİRAL PIPE WITH WIRE



KOD CODE	ÜRÜN ADI PRODUCT NAME	İÇ ÇAP INSIDE	DIŞ ÇAP OUTSIDE	MT. PACK	FİYAT-MT PRICE-MT
PLN-PLST-14	14 mm Plastik SİRİRAL Boru	14	18.1	100	10.23 ₺
PLN-PLST-16	16 mm Plastik SİRİRAL Boru	16	19.8	100	11.44 ₺
PLN-PLST-18	18 mm Plastik SİRİRAL Boru	18	22.1	100	13.49 ₺
PLN-PLST-20	20 mm Plastik SİRİRAL Boru	20	24.2	100	15.47 ₺
PLN-PLST-25	25 mm Plastik SİRİRAL Boru	25	28.9	100	19.42 ₺
PLN-PLST-32	32 mm Plastik SİRİRAL Boru	32	36	50	30.25 ₺

H. FREE ALEV YAYAN TURUNCU PLASTİK SİRİAL BORU

H. FREE FLAMMABLE ORANGE PLASTIC SPIRAL PIPE

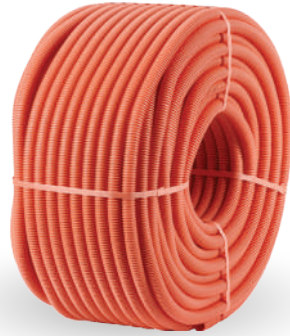

KOD CODE	ÜRÜN ADI PRODUCT NAME	İÇ ÇAP INSIDE	DIŞ ÇAP OUTSIDE	MT. PACK	FİYAT-MT PRICE-MT
PLN-PLSH-14	14 mm H. Free Turuncu Spiral Boru	14	18.1	100	9.32 ₺
PLN-PLSH-16	16 mm H. Free Turuncu Spiral Boru	16	19.8	100	12.07 ₺
PLN-PLSH-18	18 mm H. Free Turuncu Spiral Boru	18	22.1	100	13.03 ₺
PLN-PLSH-20	20 mm H. Free Turuncu Spiral Boru	20	24.2	100	15.04 ₺
PLN-PLSH-25	25 mm H. Free Turuncu Spiral Boru	25	28.9	100	19.64 ₺
PLN-PLSH-32	32 mm H. Free Turuncu Spiral Boru	32	36	50	91.07 ₺

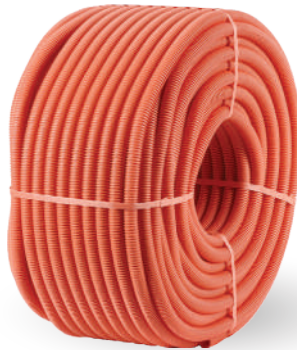

H. FREE ALEV YAYAN TURUNCU PLASTİK SİRİAL BORU KILAVUZ TELLİ

H. FREE FLAMMABLE ORANGE PLASTIC SPIRAL PIPE WITH WIRE

KOD CODE	ÜRÜN ADI PRODUCT NAME	İÇ ÇAP INSIDE	DIŞ ÇAP OUTSIDE	MT. PACK	FİYAT-MT PRICE-MT
PLN-PLSHT-14	14 mm H. Free Turuncu Spiral Boru	14	18.1	100	10.97 ₺
PLN-PLSHT-16	16 mm H. Free Turuncu Spiral Boru	16	19.8	100	12.79 ₺
PLN-PLSHT-18	18 mm H. Free Turuncu Spiral Boru	18	22.1	100	15.12 ₺
PLN-PLSHT-20	20 mm H. Free Turuncu Spiral Boru	20	24.2	100	17.87 ₺
PLN-PLSHT-25	25 mm H. Free Turuncu Spiral Boru	25	28.9	100	21.80 ₺
PLN-PLSHT-32	32 mm H. Free Turuncu Spiral Boru	32	36	50	33.97 ₺

Plastik Alman Susta (Takviyeli) Plastic Strina (Consolidated)



KOD CODE	ÜRÜN ÖLÇÜLERİ - SIZE	KOLİ BOX	FİYATI-ADET PRICE-PCS
PLN-PS-5	5 mt plastik susta - 5 mt plastic strina consolidated	40	250.00 ₺
PLN-PS-10	10 mt plastik susta - 10 mt plastic strina consolidated	25	270.00 ₺
PLN-PS-15	15 mt plastik susta - 15 mt plastic strina consolidated	20	400.00 ₺
PLN-PS-20	20 mt plastik susta - 20 mt plastic strina consolidated	15	535.00 ₺
PLN-PS-25	25 mt plastik susta - 25 mt plastic strina consolidated	13	720.00 ₺
PLN-PS-30	30 mt plastik susta - 30 mt plastic strina consolidated	10	840.00 ₺

Çelik Susta Steel Strina



KOD CODE	ÜRÜN ÖLÇÜLERİ - SIZE	KOLİ BOX	FİYATI-ADET PRICE-PCS
PLN-ÇS-5	5 mt çelik susta - 5 mt steel strina	40	280.00 ₺
PLN-ÇS-10	10 mt çelik susta - 10 mt steel strina	25	358.00 ₺
PLN-ÇS-15	15 mt çelik susta - 15 mt steel strina	20	524.00 ₺
PLN-ÇS-20	20 mt çelik susta - 20 mt steel strina	15	682.00 ₺
PLN-ÇS-25	25 mt çelik susta - 25 mt steel strina	13	812.00 ₺
PLN-ÇS-30	30 mt çelik susta - 30 mt steel strina	10	980.00 ₺

Çelik Susta (Takviyeli) Steel Strina (Consolidated)



KOD CODE	ÜRÜN ÖLÇÜLERİ - SIZE	KOLİ BOX	FİYATI-ADET PRICE-PCS
PLN-ÇST-5	5 mt çelik susta - 5 mt steel strina consolidated	40	328.00 ₺
PLN-ÇST-10	10 mt çelik susta - 10 mt steel strina consolidated	25	445.00 ₺
PLN-ÇST-15	15 mt çelik susta - 15 mt steel strina consolidated	20	681.00 ₺
PLN-ÇST-20	20 mt çelik susta - 20 mt steel strina consolidated	15	910.00 ₺
PLN-ÇST-25	25 mt çelik susta - 25 mt steel strina consolidated	13	1.140.00 ₺
PLN-ÇST-30	30 mt çelik susta - 30 mt steel strina consolidated	10	1.360.00 ₺

CCA KABLO

MAKARALI UZATMA KABLOSU ROLLER EXTENSION CABLE



KOD CODE	KESİT SIZE	KESİT SECTION	KOLİ İÇİ CTN - PCS	FİYATI-ADET PRICE-PCS
PLN-M	Boş Makara	Boş / Spool Empty	4	746.00 ₺
PLN-20	20 MT	3 x 1,5 mm ²	2	1.233.00 ₺
PLN-35	35 MT	3 x 1,5 mm ²	2	1.780.00 ₺
PLN-50	50 MT	3 x 1,5 mm ²	2	2.190.00 ₺
PLN-A20	20 MT	3 x 2,5 mm ²	2	1.640.00 ₺
PLN-A30	30 MT	3 x 2,5 mm ²	2	2.080.00 ₺
PLN-A40	40 MT	3 x 2,5 mm ²	2	2.560.00 ₺
PLN-A50	50 MT	3 x 2,5 mm ²	2	2.980.00 ₺

ASKI TİJ TAKIMI HANGER ROD SET



KOD CODE	ÜRÜN - PRODUCT	KUTU BOX	KOLİ BOX	FİYATI-ADET PRICE-PCS
PDT01	Aski Tij Takımı	50	300	46.28 ₺

Çivili Kroşe Concrete Nail Crochet



KOD CODE	ÜRÜN PRODUCT	KOLİ BOX	FİYATI-ADET PRICE-PCS
PLN-Ç-0	0 NO. ÇİVİLİ KROŞE 5 mm	20.000	0,650 ₺
PLN-Ç-1	1 NO. ÇİVİLİ KROŞE 4 mm	20.000	0,650 ₺
PLN-Ç-2	2 NO. ÇİVİLİ KROŞE 6 mm	20.000	0,650 ₺
PLN-Ç-3	3 NO. ÇİVİLİ KROŞE 8 mm	20.000	0,850 ₺
PLN-Ç-4	4 NO. ÇİVİLİ KROŞE 10 mm	20.000	0,850 ₺
PLN-Ç-5	5 NO. ÇİVİLİ KROŞE 11 mm	10.000	1,300 ₺
PLN-Ç-6	6 NO. ÇİVİLİ KROŞE 12 mm	10.000	1,300 ₺
PLN-Ç-7	7 NO. ÇİVİLİ KROŞE 16 mm	10.000	2,500 ₺
PLN-Ç-8	8 NO. ÇİVİLİ KROŞE 22 mm	6.000	3.180 ₺

Dübel Dowel



KOD CODE	ÜRÜN PRODUCT	PAKET PACKAGE	KOLİ BOX	FİYATI-ADET PRICE-PCS
PLN-RL-04	7 mm Dübel	1.000	25.000	0,307 ₺
PLN-RL-05	8 mm Dübel	1.000	25.000	0,404 ₺

Kablo Bağı Dübeli Cable Tie Dowel



KOD CODE	ÜRÜN PRODUCT	PAKET PACKAGE	KOLİ BOX	FİYATI-ADET PRICE-PCS
PLN-KB-7	Delikli Duvar Kroşe 7 mm	100	10.000	1,890 ₺
PLN-KB-8	Kablo Bağı Dübeli 8 mm (Lok Kroşe)	100	5.000	2,600 ₺
PLN-KB-10	Kablo Bağı Dübeli 10 mm (Lok Kroşe)	100	5.000	2,940 ₺

20 x 20 x 20

Menhol Underground Junction Box

KOD CODE	ÜRÜN PRODUCT	KOLİ BOX	FİYATI-ADET PRICE-PCS
PLN-MNH-20C	20 x 20 x 20 Menhol Düz Kapaklı-Contalı 20 x 20 x 20 Manhole with Flat Cover-Gasket	1/20	360,00 ₺

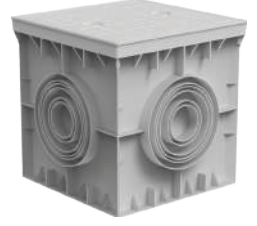
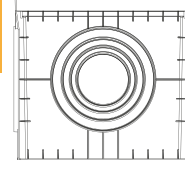

30 x 30 x 30

Menhol Underground Junction Box

KOD CODE	ÜRÜN PRODUCT	KOLİ BOX	FİYATI-ADET PRICE-PCS
PLN-MNH-30C	30 x 30 x 30 Menhol Düz Kapaklı 4 Çıkışlı - Contalı 30 x 30 x 30 Manhole Flat Covered 4 Outlet - With Gasket	4	790.00 ₺
PLN-MNH-30C6	Menhol 6 Çıkışlı Kapaklı - Contalı Manhole 6 Outlet Covered - Gasketed	4	888.00 ₺

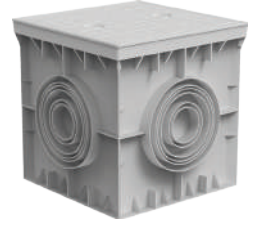
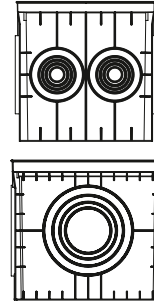

40 x 40 x 40

Menhol Underground Junction Box

KOD CODE	ÜRÜN PRODUCT	KOLİ BOX	FİYATI-ADET PRICE-PCS
PLN-MNH-40C	40 x 40 x 40 Menhol Düz Kapaklı 4 Çıkışlı - Contalı 40 x 40 x 40 Manhole Flat Covered 4 Outlet - With Gasket	2	1.600,00 ₺
PLN-MNH-40C6	Menhol 4 Çıkışlı Kapaklı - Contalı Manhole 4 Outlet Covered - Gasketed	2	1.740,00 ₺

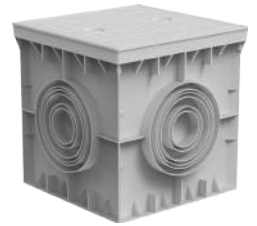
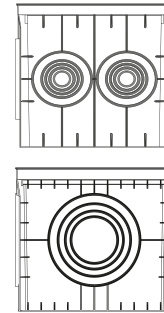

55 x 55 x 50

Menhol Underground Junction Box

KOD CODE	ÜRÜN PRODUCT	KOLİ BOX	FİYATI-ADET PRICE-PCS
PLN-MNH-50C	55 x 55 x 50 Menhol Düz Kapaklı 4 Çıkışlı - Contalı 55 x 55 x 50 Manhole Flat Covered 4 Outlet - With Gasket	1	3.205,00 ₺
PLN-MNH-50C6	Menhol 10 Çıkışlı Kapaklı - Contalı Manhole 10 Outlet Covered - Gasketed	1	3.500,00 ₺

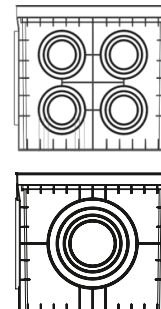

CURTAIN RAIL
ACCESSORIES

PERDE RAYI AKSESUARLARI





2'li Dönüş - 2 Gang Turn

Ürün Kodu - Product Code

PLN-245

Paket İçi Adet - Pcs in Package

60

Fiyat Adet - Price PCS

33.00 ₺



45°

2'li Dönüş - 2 Gang Turn

Ürün Kodu - Product Code

PLN-290

Paket İçi Adet - Pcs in Package

50

Fiyat Adet - Price PCS

28.00 ₺



90°



3'lü Dönüş - 3 Gang Turn



Ürün Kodu - Product Code

PLN-345

Paket İçi Adet - Pcs in Package

60

Fiyat Adet - Price PCS

38.00 ₺

45°



3'lü Dönüş - 3 Gang Turn



Ürün Kodu - Product Code

PLN-390

Paket İçi Adet - Pcs in Package

50

Fiyat Adet - Price PCS

35.93 ₺

90°



4'lü Dönüş - 4 Gang Turn



Ürün Kodu - Product Code

PLN-490

Paket İçi Adet - Pcs in Package

30

Fiyat Adet - Price PCS

73.00 ₺

90°



2'li Final - 2 Gang Final



Ürün Kodu - Product Code

PLN-2F

Paket İçi Adet - Pcs in Package

60

Fiyat Adet - Price PCS

14.00 ₺



3'lü Final - 3 Gang Final



Ürün Kodu - Product Code

PLN-3F

Paket İçi Adet - Pcs in Package

60

Fiyat Adet - Price PCS

20.00 ₺



4'lü Final - 4 Gang Final

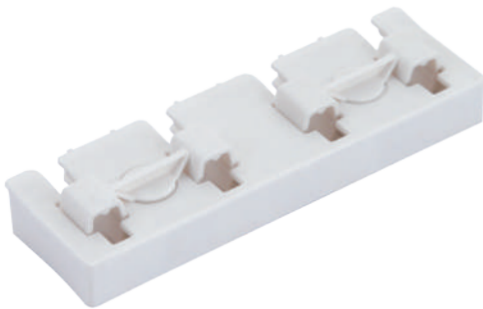

Ürün Kodu - Product Code

PLN-4F

Paket İçi Adet - Pcs in Package

60

Fiyat Adet - Price PCS

26.90 ₺



2'li Ek - 2 Gang Add

Ürün Kodu - Product Code

PLN-2E

Paket İçi Adet - Pcs in Package

60

Fiyat Adet - Price PCS

17.90 ₺



3'lü Ek - 3 Gang Add

Ürün Kodu - Product Code

PLN-3E

Paket İçi Adet - Pcs in Package

60

Fiyat Adet - Price PCS

20.00 ₺

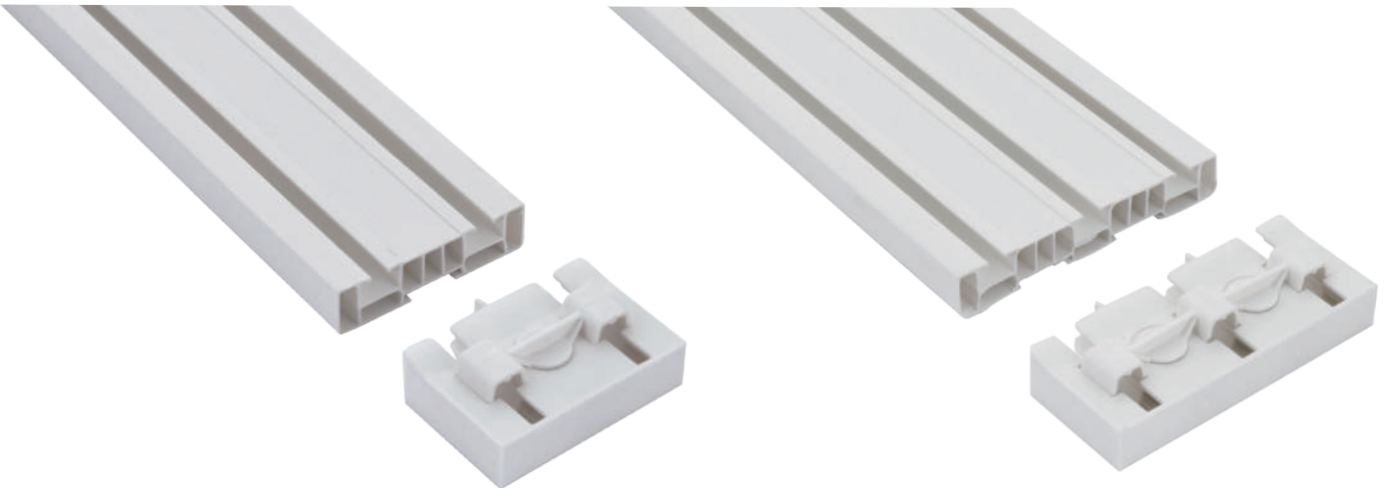
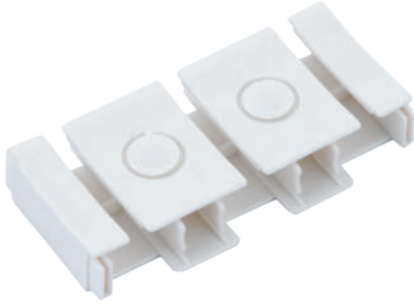

Kilitli Rulet - Plug-Roulette



Ürün Kodu - Product Code	PLN-RL-01
Kutu - Box	1000
Fiyat Paket - Price Pack	239.00 ₺

Final Stop - Final Stop



Ürün Kodu - Product Code	PLN-RL-03
Kutu - Box	1000
Fiyat Paket - Price Pack	660.00 ₺

L Profil - L Profile

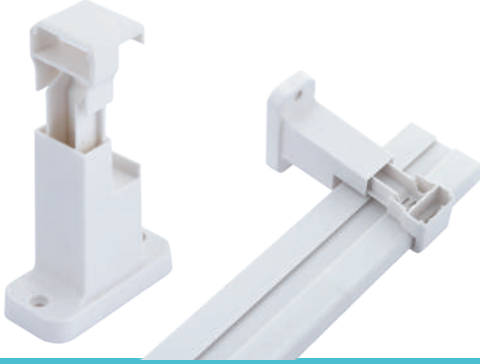

Ürün Kodu - Product Code	PLN-L
Kutu - Box	60
Fiyat Adet - Price PCS	16.50 ₺

Çivili Dübel - Spiked Peg

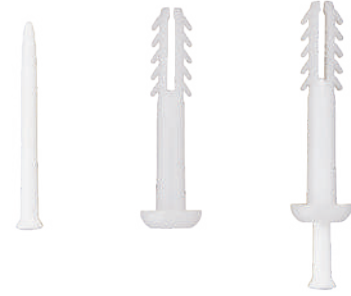

Ürün Kodu - Product Code	PLN-RL-02
Kutu - Box	500
Fiyat Paket - Price Pack	790.00 ₺

2'li Korniş Kapağı - 2 Cornice Covers



Ürün Kodu - Product Code	PLN-KRNS-02
Kutu - Box	500
Fiyat Paket - Price Pack	17.50 ₺

3'lü Korniş Kapağı - 3 Cornice Covers



Ürün Kodu - Product Code	PLN-KRNS-03
Kutu - Box	500
Fiyat Paket - Price Pack	16.00 ₺



TÜRK STANDARDLARI ENSTİTÜSÜ
DENEY ve KALİBRASYON
MERKEZİ BAŞKANLIĞI
ELEKTROTEKNİK LABORATUVARI ANKARA
MÜDÜRLÜĞÜ

TURKISH STANDARDS INSTITUTION
HEADSHIP OF TSE TEST and CALIBRATION CENTER
Electrotechnical Laboratory Ankara

Necatbey Cad. No:112 Bakanlıklar / ANKARA / TÜRKİYE

Tel: 0312 416 6553 Faks: e-mail: elektrotekniklabankara@tse.org.tr

www.tse.org.tr

136408

05-23

MUAYENE VE DENEY RAPORU
TEST REPORT

Deneyi Talep Eden/Firma : (Adı, Adresi, Şehir vb.) Requesting/Customer (Name, Address, City etc.)	PLANET PLASTİK ELEKTRİK SANAYİ VE DİŞ TİCARET ANONİM ŞİRKETİ
Deney Talep Tarihi / No : Order Date/No.	17.04.2023 / 2023-85426
Numunenin Tanımı : (Cins, Marka, Sınıf, Tip, Tür, Model vb.) Sample Description (Type, Mark, Class, Model etc.)	2023-123586. PVC KABLO KANALI, PLANET PLASTİK ELEKTRİK, 40X40, PROFİL, KABLO KANALI, BEYAZ RENK, 1.00, metre
Numune Kabul Tarihi : Sample Receipt Date	27.04.2023
Deneylerin Yapıldığı Tarih : Date of Test	28.04.2023 / 03.05.2023
Uygulanan Standart Metot : Applied Standard/Method	Özel Deney (Borular-Buatlar-Kutular)(İç Tesisit)
Raporun Sayfa Sayısı : Number of pages of the report	3
Deney Sonucu : Test Result	-
Açıklamalar : Remarks	Özel Deney

Yukarıda tanımlanan numune için laboratuvarımızda yapılan muayene ve deneylerden elde edilen sonuçlar müteakip sayfalarda verilmiştir.
The testing and/or measurement results are given on the following pages which are part of this report.

Karekod QR Code	Tarih Date	Deney Sorumlusu Person in charge of test	Kontrol Eden Reviewer	Onaylayan Head of Laboratory
	03.05.2023	AHMET NEDİM DOĞAN	BERTAN KAHRAMAN	MUHAMMED HÜSEYİN ALKAN

Bu rapor, hazırlayan laboratuvarın yazılı izni olmadan kısmen kopyalanıp çoğaltılamaz. İmzasız ve karekodsuz raporlar geçersizdir. Bu rapor, sadece deneyi yapılan numune için geçerlidir ve "Ürün Belgesi" yerine geçmez.
This test report shall not be reproduced other than in full except with the written permission of the laboratory. Test reports without signature and seal are not valid. This test report represents only tested sample(s), and shall not be used as Product Certificate.

Bu doküman elektronik ortamda imzalanmıştır.

Doğrulama adresi: <https://basvuru.tse.org.tr/uye/QRKodDogrulama?code=D9AA2B>

Sertifika Certificate

PLANET PLASTİK ELEKTRİK SANAYİ VE DİŞ TİCARET ANONİM ŞİRKETİ

İSBM MH. ESKİ TURGUT ÖZAL CD. ALTINTAÇ İŞ MRKZ. NO:3404 BAŞAKŞEHİR / İSTANBUL

DSR BELGELENDİRME tarafından denetlenmiş ve uygulamakta olduğu
Kalite Yönetim Sisteminin

is audited by DSR Certification and applied
Quality Management System meet the requirements of

ISO 9001:2015

standartına aşağıdaki kapsamda uymakta olduğu gözlemlenmiştir.
standard for the following activities.

PVC KABLO KANALI VE AKSESUARLARI, PLASTİK SİRAL, ÇELİK VE İZOLELİ SİRAL BORU
İMALATI, PVC RÜJİT BORULAR, ABS PANO VE TERMOPLASTİK BUALAR, BANYO ASPİRATÖRLERİ,
KABLO BAĞI, KABLO MAKARASI, MENHOL, AYDINLATMA VE PLASTİK ÇELİK SUSTALAR, SİGORTA
KUTUSU, GRUP PRİZ VE AKSESUARLARI VB. ELEKTRİK MALZEMELERİ SATIŞI

PVC CABLE TRUNKINGS AND ACCESSORIES, PLASTIC SPIRAL, STEEL AND INSULATED STEEL SPIRAL
MANUFACTURING, PVC RIGID PIPES, ABS PANEL BOARD AND THERMOPLASTIC JUNCTION BOXES,
ASPIRATORS, CABLE TIES, CABLE REEL, MENHOLE PLASTIC AND STEEL GUIDES, FUSE BOXES, GROUP
SOCKETS AND ACCESSORIES, AND SELLING OF OTHER ELECTRICAL MATERIALS.

Sertifika No / Certificate No: QMS-23.04.311

06.04.2023
Sertifika Tarihi
Certificate Date

06.04.2023
Sertifika Son Basmı Tarihi
Certificate Last Issue Date

05.04.2024
Sertifika Geçerlik Tarihi
Certificate Expiry Date

3 Yılı/ Years
Belgelendirme Periyodu
Certification Period

EA Kodu/EA Code: 29



DSR TEKNİK MUAYENE SERTİFİKASYON HİZ. LTD. ŞTİ.
Yenişehir Mah. Selvili Sk. Heliç Beyaz Ofis 2/1 A Blok No:297 PENCİK / İSTANBUL / TÜRKİYE Tel: +90 216 806 00 25
E-mail: info@dsrbelgelendirme.com.tr - Web: www.dsrbelgelendirme.com.tr

EU DECLARATION OF CONFORMITY

AB UYGUNLUK BEYANI

Manufacturer name
Üretici adı
Manufacturer address
Üretici adresi

PLANET PLASTİK ELEKTRİK SANAYİ VE DIŞ TİCARET ANONİM ŞİRKETİ
İosb Mh. Eski Turgut Özal Cd. Altınış İş Mrkz. No.8/404
Başakşehir İstanbul Turkey

Product specification
Ürün tanımlaması

Cable trunking systems and cable ducting systems for electrical installations
Elektrik tesisatı için kablo kanal sistemleri ve kablo kanal sistemleri

Types
Tipler

CLOSED TYPE CABLE TRUNKINGS
KAPALI TİP KABLO KANALLARI
INSIDE COVER CABLE TRUNKING AND ACCESSORIES
İÇTEN KAPAKLI KABLO KANALI VE AKSESUARLARI
SELF ADHESIVE CABLE TRUNKINGS
YAPIŞKAN BANTLI KABLO KANALLARI
OVERFLOOR PVC CABLE TRUNKINGS GREY
ZEMİN ÜSTÜ (BALIK SIRT) PVC KABLO KANALLARI GRİ
PVC SLOTTED CABLE TRUNKINGS GREY
DELİKLİ (PANO TİPİ) PVC KABLO KANALLARI GRİ

Trade name(s)
Marka adları



European directive(s)
İlgili AT direktifleri

Low Voltage Equipment Directive (2014/35/EU)
Belirli Gerilim Sınırları İçin Tasarlanan Elektrikli Ekipman İle İlgili Yönetmelik (2014/35/AB)

European standart(s)
İlgili AT standartlar

EN 50085-1:2005+A1:2013
EN 50085-2-1:2006+A1:2011
EN 50085-2-3:2010

This declaration of conformity is issued under the sole responsibility of the manufacturer.
Bu uygunluk deklarasyonu üreticinin kendi sorumluluğunda düzenlenmiştir.

The object of the declaration described above is in conformity with the relevant European Union harmonization legislation:
Yukarıda açıklanan deklarasyonun amacı, ilgili Avrupa Birliği uyum mevzuatı ile uygun olduğudur

Signed for and on behalf of the PLANET PLASTİK ELEKTRİK SANAYİ VE DIŞ TİCARET ANONİM ŞİRKETİ
PLANET PLASTİK ELEKTRİK SANAYİ VE DIŞ TİCARET ANONİM ŞİRKETİ adına
Signature
İmza

Name, Function (İsim, Görevi): Caner Can, General Manager (Genel müdür)
Place of issue (Yayınlanma yeri): İstanbul – Turkey
Date of issue (Yayınlanma tarihi): 1.05.2023



EU DECLARATION OF CONFORMITY

AB UYGUNLUK BEYANI

Manufacturer name
Üretici adı
Manufacturer address
Üretici adresi

PLANET PLASTİK ELEKTRİK SANAYİ VE DIŞ TİCARET ANONİM ŞİRKETİ
İosb Mh. Eski Turgut Özal Cd. Altınış İş Mrkz. No.8/404
Başakşehir İstanbul Turkey

Product specification
Ürün tanımlaması

FLEXIBLE CONDUIT SYSTEMS
BÜKÜLGEN BORU SİSTEMLERİ

Types
Tipler

PLASTIC
PLASTİK

Trade name(s)
Marka adları



European directive(s)
İlgili AT direktifleri

Low Voltage Equipment Directive (2014/35/EU)
Belirli Gerilim Sınırları İçin Tasarlanan Elektrikli Ekipman İle İlgili Yönetmelik (2014/35/AB)

European standart(s)
İlgili AT standartlar

EN 61386-1:2008+A1:2019
EN 61386-23:2004+A11:2010

This declaration of conformity is issued under the sole responsibility of the manufacturer.
Bu uygunluk deklarasyonu üreticinin kendi sorumluluğunda düzenlenmiştir.

The object of the declaration described above is in conformity with the relevant European Union harmonization legislation:
Yukarıda açıklanan deklarasyonun amacı, ilgili Avrupa Birliği uyum mevzuatı ile uygun olduğudur

Signed for and on behalf of the PLANET PLASTİK ELEKTRİK SANAYİ VE DIŞ TİCARET ANONİM ŞİRKETİ
PLANET PLASTİK ELEKTRİK SANAYİ VE DIŞ TİCARET ANONİM ŞİRKETİ adına
Signature
İmza

Name, Function (İsim, Görevi): Caner Can, General Manager (Genel müdür)
Place of issue (Yayınlanma yeri): İstanbul – Turkey
Date of issue (Yayınlanma tarihi): 1.05.2023





Fabrika - Factory

İkitelli OSB Mah. Eski Turgut Özal Cad.
Altıntaş İş Merkezi. D BLOK No:8 3/303
Başakşehir/İstanbul, Türkiye

+90 212 436 46 46

info@planetelektrik.com.tr

www.planetelektrik.com.tr